

# **POWERNAIL® CO.**

## ***Powernail 50P FLEX Pneumatic Powernailer®***



### **OPERATION AND MAINTENANCE MANUAL MANUAL DE OPERACION Y DE MANTENIMIENTO MANUEL D'INSTRUCTIONS ET D'ENTRETIEN**

#### **WARNING**



Read this manual before you use this Powernailer®. Follow all safety warnings and instructions. If you are uncertain about the operation of the nailer, call us directly at 1-800-323-1653 for assistance or contact the closest Powernail Dealer for help. Please retain this information for future reference.

## **INTRODUCTION**

The Powernail FLEX Pneumatic Nailer is designed to bring Powernail quality to a pneumatic nailer. For those looking for the ease of use of a pneumatic tool, the Powernail FLEX is designed for use with only 1" , 1-1/4", 1-1/2" and 1-3/4" (18 gage) Powercleats® nails.

The Powernail FLEX is recommended for use on thinner 3/8", 1/2", 5/8" and 3/4" solid tongue and groove hardwood as well as some other hard exotics, bamboo, and engineered woods.

For a superior pneumatic Nailer, look to the company that has been the industry's quality leader, **POWERNAIL® COMPANY, INC.**

## **INDEX**

Index.....	2	Parts List.....	10-11
Warranty.....	2	Seal Locations Diagram.....	12
Safety Instructions.....	3	Schematic .....	13
Powernail Company Info.....	3	Depth Chart.....	14
Operating Instructions.....	4-8	Troubleshooting Chart.....	15
Parts & Service.....	5-8	Accessory Products.....	16
Drive Blade.....	6		
Seal Replacement.....	6-7		
Safety Labels.....	9		

## **LIMITED WARRANTY**

POWERNAIL® Company, Inc. warrants to its customer, and to the first end-use purchaser of POWERNAIL flooring nailers purchased from an authorized POWERNAIL distributor, that each serialized manufactured nailer by POWERNAIL®, for a period of 12 months from the date of purchase, and with respect to the nailer body (specifically Models 200, 445, and 50P), for a period of 10 years from date of purchase, (“warranty period”); shall be free of defects in materials and workmanship and will meet POWERNAIL’s specifications in effect at the time of Product shipment. POWERNAIL will repair or replace, at its option, any Powernailer® that does not conform to this warranty. Claims must be made no later than fifteen (15) days after the end of the warranty period. POWERNAIL will perform all repair or replacements itself or through its authorized contractors. POWERNAIL is not responsible for shipping, labor or other direct or indirect costs. Damage caused by abuse, misuse, unusual or excessive wear is excluded. Repair or modification of the Products by unauthorized parties will void this warranty. The customer is responsible for returning Products to POWERNAIL for verification of nonconformance. Warranties for Products not manufactured by POWERNAIL are limited to warranties provided to POWERNAIL by the manufacturer of such product that are assignable to customer.

THESE WARRANTIES AND REMEDIES ARE EXCLUSIVE OF ALL OTHERS, EXPRESS OR IMPLIED. THE WARRANTIES OF MERCHANTABILITY AND FITNESS FOR PURPOSE ARE EXPRESSLY EXCLUDED. IN NO EVENT SHALL POWERNAIL’S LIABILITY FOR A WARRANTY CLAIM EXCEED THE PRICE PAID TO POWERNAIL FOR THE NONCONFORMING PRODUCT, REGARDLESS OF THE FORM OR BASIS OF THE CLAIM OR CAUSE OF ACTION.

## **SAFETY INSTRUCTIONS**



Always use approved **SAFETY GLASSES** and **EAR PROTECTION** when operating this Nailer. The operator and others in the work area should always wear approved **FRONT** and **SIDE** eye protection when operating this Nailer. Eye protection will help guard against flying nails and debris, which could cause severe eye injury.



**EYE AND EAR PROTECTION** should be used to prevent hearing damage when there are high noise levels in the work area.

ALWAYS use ear plugs with a noise reduction rated at 29 db or higher at a construction site.

Nailer noise ratings are at LPA-1sd=90.6,  
LWA-1sd=99.3 and LPA-1s,1m=86.3.  
Nailer vibration rating: m/s<sup>2</sup>=3.05.

Always **DISCONNECT THE AIR SUPPLY** before making any adjustments, repairing, clearing jams or when the Nailer is not in use. Do not use on scaffolding or ladders and disconnect nailer from air supply when transporting between installation areas.

Never attach the female end of a quick disconnect to the Nailer. This will trap air inside the Nailer and permit it to be discharged. Only the unrestricted male connection should be attached to the Nailer.

Nailer requires an air source that can continuously deliver 80 to 110 psi at 3-1/2 cubic feet of air per minute for operation.

Normal air pressure should not exceed 120 psi or damage to the Nailer and seals may occur. Excess air pressure can cause the Nailer to explode.

To prevent fire or explosion, use only regulated compressed air—do not use bottled gases of any kind (no oxygen or combustible gasses) to power this Nailer.

Nailer is intended for use installing wood flooring and is not to be used for purposes not specified in the operations manual.

The trigger is a safety device and should only be pulled when the Nailer is in proper Position on the work surface and before the plunger is struck with the mallet. Do not tie or tape down the safety trigger as the Nailer could discharge if dropped on the plunger. The Nailer will not fire unless the trigger is pulled before the mallet blow. Do not use the trigger safety as a lock up for the plunger then rack the wood using the locked up Nailer body. It will severely damage the Mechanism and the Nailer. Use the mallet to rack the wood strip, not the Nailer.

Do not use any nails other than Powernail Powercleats Nails which are specifically designed for use in any Powernailer. Powercleats Nails are available in various lengths. Contact your Powernail Dealer for Powercleats Nails.

Use only Powernail replacement parts in the repair or maintenance of this nailer. Parts or repair services are available from the manufacturer or from agents authorised by the manufacturer. Repairs should be carried out only by trained service personnel in the field of fastener driving tools who will observe proper safety controls while performing maintenance. Service personnel should be qualified to assess the safe working condition of fastener driving tools.



Never place any part of the body in the discharge path of the Nailer when air is connected to the Nailer. Always make sure Nailer is empty of cleats before connecting air hose so as to prevent any accidental discharge from occurring.

Never leave the Nailer unattended while it is connected to an air supply.

Whenever air is connected to the Nailer, keep body parts away from the nail discharge path. Disconnect the air line before making adjustments or repairs on the Nailer. Only connect air to an unloaded Nailer so as to prevent accidental discharge.

**POWERNAIL COMPANY, INC.**  
**1300 Rose Road, Lake Zurich, IL 60047 US**  
**Phone: 1-800-323-1653 OR 847-847-3000**  
**www.powernail.com**

## OPERATION

### Read these instructions carefully before you use the Nailer.

To use the Powernail Flex, adjust the nailer FLEX foot to a sample of your flooring (see instructions below).

When the nailer foot is adjusted to your flooring, simply place the nailer on the floor and pull nailer back so the locating ears (Figure 3) catch the edge of the floor above the tongue. Pull the safety trigger and hit the plunger with the rubber-capped mallet-end to let the Nailer drive and set the nail at the correct 45 degree angle.

#### **FLEX Foot Adjustment:**

Wood varies from one manufacturer to the next. The different wood profiles may be due to height and length of the flooring tongue and whether or not there is a nail pocket.

First, loosen the two hex bolts under the FLEX foot with the Allen Wrench supplied with the nailer. (Figure. 1.)

Next, set the nailer on a sample of your flooring (see Figure 2).

Use the adjustment lever at the back of the nailer foot to raise or lower the nailer to the wood.

Match the Adapter Foot Locating Ear so that it is pointing into the 90° angle created by the tongue and the top of the wood (see Figure 3).

For wood with a nail pocket, line up the Locating Ear at the top of the nail pocket.

When the adjustment lever is in the correct position for your wood sample, tighten the two hex bolts to lock the FLEX foot into place.

Always check your adjustment with a sample to ensure the nail is driving into the nail pocket.

#### **To Load the Powernail Flex:**

Place up to one stick (100) of Powercleats® (18 gage) nails, 1" , 1-1/4" , 1-1/2" or 1-3/4" long into the nail channel feed slot. Pull back the spring loaded nail pusher over the nails until it contacts the last nail and slowly release the nail pusher.

#### **To Unload**

To remove nails from the nail channel, pull the two round knobs on the nail pusher together. This will clear it from the nail path. Then turn the nailer over so the nails slide out of the channel.

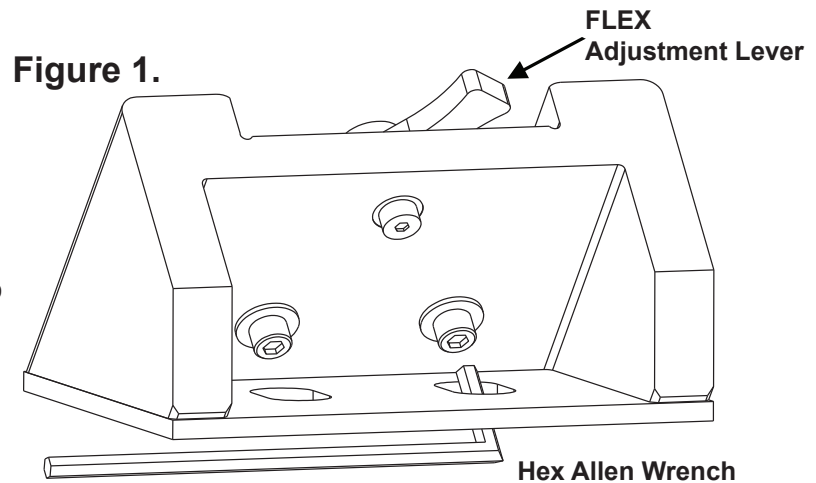

1. Loosen 2 hex screws.
2. Raise or lower the FLEX to your wood sample.
3. Match the Locating Ear to the nail pocket.
4. Tighten 2 hex screws.
5. Test wood sample with new adjustment.

#### **Figure 2.**

Set the nailer on a sample of your flooring.



#### **Figure 3.**

Raise the nailer foot above the tongue to line up the nail pocket.

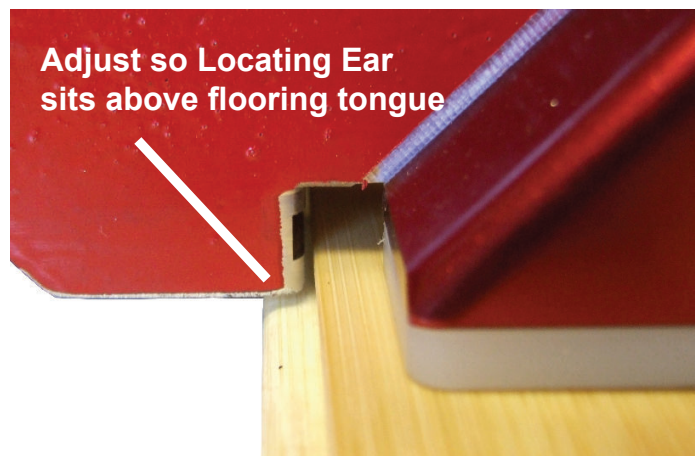

## **OPERATION, continued...**

**WARNING:** It is not necessary to hit the Nailer hard to activate it. Never hit the Nailer with excessive force or with the metal end of the mallet, this will damage the Nailer.

Never use the Safety Trigger interlock to lock up the plunger and rack the wood with blows to the Nailer body. This will severely damage the safety mechanism and Nailer. This abuse and damage is not covered by the warranty.

Before each use check all screws to be sure they are tight. Shock and vibration can loosen screws. Do not over tighten any screw.

### **AIR SUPPLY:**

The air must be clean and dry. Dirty and/or wet air will damage the Nailer. A combination filter-regulator-lubricator is required for proper Nailer performance and should be placed close to the Nailer per manufacturer's recommendations.

The air source must continuously deliver 80 to 110 psi at 3-1/2 cubic feet of air per minute to operate the Nailer. Connect a clean air hose and air regulator to the Nailer.

Check for air supply leaks that waste air and starve the Nailer of air thereby reducing its performance.

### **LUBRICATION:**

If you do not use an in line lubricator, you must lubricate the Nailer manually. The frequency of lubrication is dependent upon the duty cycle of the Nailer. Continuous duty requires more frequent oiling than intermittent duty.

At least every eight (8) hours place two to four drops of Pneumatic Light Air Tool Oil into the disconnected air line male connector attached to the Nailer. **WARNING:** Detergent oil is not recommended and may damage the seals.

**WARNING:** Do not over lubricate the Nailer, excess oil mist or drops will be vented with spent air when over lubricated. Excess oil could stain the wood flooring, walls or furnishings. Dry fire the Nailer, without nails, to purge excess oil, before you begin to nail down flooring. **We will not be responsible for oil stains.** Before storing the Nailer, lubricate and cycle the Nailer in insure internal parts are oil protected from corrosion.

### **PARTS & SERVICE:**

When ordering parts include the part number, part description, Powernailer model and serial number. Be sure to state the quantity of the part(s) required. Contact your Powernail Dealer for the necessary parts or service.

**WARNING:** Never work on the Nailer if the air line is attached. Always disconnect the air line from the Nailer first.

### **NAILER DISASSEMBLY:**

#### **TO REPLACE RUBBER BUMPER (#31):**

1. Disconnect the air supply
2. Remove the four (4) cap screws holding the Adapter Foot, Foot and Nail Channel assembly to the main Body (see illustration).
3. Pull the Rubber Bumper out of the cylinder bore. Replace the old Bumper if it shows signs of wear or it is split.
4. Reverse these steps to reassemble the Nailer. Be sure to align the Driving Blade with the slot in the Nail Channel Assembly while you reassemble the Nailer. **NEVER FIRE THE NAILER WITHOUT THE RUBBER BUMPER INSTALLED, IT WILL DAMAGE THE NAILER.**



FLEX Foot  
Adjustment Video

For Step-by-Step Videos and Instructions,  
Visit our Web Site at: [www.Powernail.com](http://www.Powernail.com)



Service and  
Maintenance Videos



## **OPERATION, continued...**

### **TO REPLACE DRIVING BLADE(#17):**

1. Disconnect the air supply
2. Remove the four socket head cap screws holding the Adapter Foot, Foot and Nail Channel Assembly to the body.
3. Remove the Rubber Bumper
4. Pull the Driving Blade with pliers until the Piston is fully extended outward towards the bottom of the cylinder.
5. Use a 15/16" box wrench (Part #: 09-445-29768) to unscrew the Driving Blade Jam Nut and remove it. Hold the Piston from turning while unscrewing the Jam Nut by holding the piston hex with a 1-1/8" box wrench (Part #: 09-445-29768).
6. Push out the 1/4" diameter blade retaining Dowel Pin and remove the broken Driving Blade stub.
7. Install a new Driving Blade in the slot and replace the Dowel Pin. Screw on the retaining Jam Nut using the same tools. If the Jam Nut becomes worn and loose after frequent removals, it should be replaced.
8. Check the fit, there should be some sideways movement between the Driving Blade and the Jam Nut assembly. This is desirable and helps the blade to align itself with the mating parts.
9. Reassemble the components. Be sure to align the Driving Blade with the slot in the Adapter Foot Assembly, it goes in only one way.

### **DRIVING BLADE ASSEMBLY REMOVAL:**

1. Disconnect the air supply.
2. Remove Rubber Plunger Cap (#18).
3. Unscrew & remove Body Cap (#2).
4. Push Safety Yoke (#26) aside and unscrew the three 10-32 cap screws holding the Plunger (#13) to the Return Cylinder (#12).
5. Pull the Plunger up and out of the Nailer Body (#1) cavity.
6. Remove the Return Cylinder O Ring Gasket (#34) located on the top of the Return Cylinder under the Plunger.

7. Turn the Nailer over and remove the four cap screws (#48), that fasten the Adapter Foot and Nail Channel Assembly to the Nailer Body and lift the Assembly off the Body.
8. Remove the Rubber Bumper (#31).
9. Pull the Driving Blade Assembly out of the Nailer Body by pulling on the Driving Blade.
10. Hold the Piston Rod (#10) with an 11/16" socket over its hex end opposite the Piston. **Do not use pliers or a vise anywhere on the metal parts, they can damage the sealing surfaces.**
11. Use box wrenches to remove the 5/8-18 Jam Nut (#49). Remove the Dowel Pin (#42) and Driving Blade (#17).
12. Unscrew the Piston from the Piston Rod using box wrenches and separate the Piston, Piston Rod and Return Cylinder.

### **SEAL REPLACEMENT:**

There are 7 seals that may require replacement. We recommend that you have your POWERNAIL Dealer replace the Seals.

### **SEAL KIT:**

You may choose to buy a Seal Replacement Kit and replace the seals yourself. It is good practice to replace all seals at one time regardless if only one seal needs replacement.

### **SEAL DESCRIPTION & NUMBER:**

1. Piston U cup Lip Seal (#19)
2. Return Cylinder U cup Lip Seal (#20)
3. Piston Rod U cup Lip Seal (#21)
4. Rubber Seat (#30)
5. Plunger Seal Set (#32)
6. Plunger Wiper Seal (#33)
7. Return Cylinder O Ring Gasket (#34)

To change Seals follow these procedures. Be sure the air line is disconnected from the Nailer first before making any repairs. Consult the illustration for the name and location of the following component parts.

## **OPERATION, continued...**

### **TO REPLACE THE SEALS:**

#### **Plunger Seal Set (#32):**

1. Remove the Teflon<sup>®</sup> Seal and its O-ring expander from the Plunger groove using a bent paper clip or pick. Be sure not to scratch the inside walls of the seal groove with the wire hook.

2. Clean out the seal groove. Place a new O-ring into the seal groove by stretching it over the Plunger body. Make sure the O-ring is not twisted in the groove. Place a new Teflon<sup>®</sup> Seal Ring into the seal groove over the O-ring.

3. Carefully push the Teflon<sup>®</sup> Seal Ring over the edge of the Plunger with your thumbs and into the groove. Do this as quickly as possible to reduce stretching of the Teflon<sup>®</sup> Seal Ring. **DO NOT OVER STRETCH THE TEFLON<sup>®</sup> SEAL RING.** Be sure the Teflon<sup>®</sup> Seal Ring is centered all around the seal groove and not twisted.

4. Wipe off the Seal surface with a clean rag and lubricate it generously with Pneumatic Light Air Tool Oil lubricant.

#### **Rubber Seat (#30):**

1. Remove the Cylinder Sleeve (#14). The Cylinder Sleeve would slide out of the Nailer Body when you pull out the Driving Blade

2. Remove the metal Support Ring (#29) and Rubber Seat from inside the Nailer body. **NOTE THAT THE CHAMFER ON THE INSIDE OF THE RUBBER SEAT FACES THE BOTTOM OF THE NAILER.** Do not reverse the direction of the chamfer when you replace the Rubber Seat.

3. Replace the Rubber Seat, Support Ring and Cylinder Sleeve. Be sure to re install the steel Cylinder Sleeve with the chamfered inside edge facing the **BOTTOM** of the Nailer.

#### **Piston U Cup Lip Seal (#19):**

1. Remove the old Piston U Cup Lip Seal from the Piston using a bent paper clip or pick, being careful not to scratch the inside walls of the seal groove or the edge of the Piston with the wire hook.

2. Clean out the seal groove. Place a new U-Cup Lip Seal into the groove. Make sure the lip seal is not twisted in the groove and the lips face the top of the Nailer. See the sketch on next page (#19).

3. Carefully wipe off the U Cup Lip Seal surface with a clean rag and lubricate it generously with Pneumatic Light Air Tool Oil lubricant.

#### **Return Cylinder U Cup Lip Seal (#20):**

1. Use a bent paper clip or pick to remove the old U Cup Lip Seal from the internal seal groove inside the Return Cylinder. Be careful not to scratch the inside walls of the seal groove with the wire hook.

2. Clean out the seal groove. Place a new U Cup Lip Seal into the groove, be sure it is not twisted in the groove. Be sure the lips are facing the inside of the Return Cylinder as shown on the Seal Placement sketch on page 10.

**WARNING:** The U-Cup Lip Seals #20 and #21 look alike, but they are different, **DO NOT** mix them up.

3. Carefully wipe off the Lip Seal surface with a clean rag and lubricate it generously with Pneumatic Light Air Tool Oil lubricant.

#### **Piston Rod U-Cup Lip Seal (#21):**

1. Remove the old U-Cup Lip Seal from the seal groove with a bent paper clip or pick using care not to scratch the inside walls of the seal groove with the wire hook.

2. Clean out the seal groove and install a new U-Cup Lip Seal. Be sure the Lips are facing the right direction and are not twisted in the groove. See the sketch on next page.

#### **Plunger Wiper Metal Cap O-Ring (#33):**

1. Use a bent paper clip to pick out the felt Wiper Seal (or O-ring) out of its groove in the Body Cap (#2).

2. Note: The new wiper is now a Rubber O-Ring.

3. Clean out the groove and insert the new rubber O-Ring.

## **OPERATION, continued...**

### **Return Cylinder O-Ring Gasket (#34):**

1. Place a new O-Ring Gasket in the groove on top of the Return Cylinder when you reassemble the Driving Blade Assembly.
2. Wipe off the O-Ring Gasket seal surface and lubricate it generously with Pneumatic Light Air Tool Oil lubricant.

### **REASSEMBLING THE NAILER:**

1. Be sure the Rubber Seat, Support Ring and Cylinder are installed in the Body and are facing the correct direction.
2. All seal surfaces must be clean and lubricated generously with Pneumatic Light Air Tool Oil lubricant.

Replace any part that shows signs of wear.

3. Use care when installing the seals into their respective cavities. Be sure the Seals are contained in their groove and do not come out as the parts slide together. Generous cavity lead in chamfers have been provided to help Seal installation.
4. Carefully insert the Piston Rod into the Return Cylinder and screw the Piston onto the rod. Be sure the Piston is facing the correct way, ears up, hex down.
5. Assemble the Driving Blade, Dowel Pin and Jam Nut on to the Piston Rod.
6. Insert the Driving Blade Assembly up into the bottom of the Nailer Body Cylinder.
7. Be sure there is a new O-Ring Gasket in the top groove of the Return Cylinder.
8. Insert the Plunger into the top cavity of the Body. Line up the holes and install the three Plunger retaining screws. It is important that the three #10-32 screws are tight or air leakage will occur. Our recommendation is to use 1-2 drops of blue Loctite® or similar on the 3 screws.

9. Install the Body Plate.

10. Position the Safety Yoke into the Plunger Groove.

11. Install the Body Cap and Plunger Rubber Cap.

12. Turn the Nailer upside down. Install the Rubber Bumper, Nail Channel Assembly and Adapter Foot. Be sure to align up the Driving Blade with the slot in the Foot before the Nailer is closed up.

13. NEVER FIRE THE NAILER WITHOUT THE RUBBER BUMPER INSTALLED, IT WILL DAMAGE THE NAILER BEYOND REPAIR.

### **TO CLEAR A NAIL JAM:**





1. It helps to tap the Driving Blade back to the retracted position before trying to remove a jammed nail. A spare Driving Blade works best for this.
2. Try to pull the jammed nail out of the gate with a pair of long nose pliers. If this does not work remove the four (4) cap screws holding the Foot, Gate and Nail Channel Assembly together.
3. Separate the Foot and Gate with a screw driver just enough to clear out the jammed nail.
4. Put thread locking compound on all screws and reassemble the components.

For Step-by-Step Videos and Instructions,  
Visit our Web Site at: [www.Powernail.com](http://www.Powernail.com)



## NAILER SAFETY DECALS

 **Warning!**

-  • Read and understand the tool labels and manuals before operating.
-  • Operators and others in work area **MUST** wear **EYE** and **EAR** protection.
-  • Use safety glasses with side shields.
-  • **NEVER** point tool at yourself or others in the work area.
- Only connect air to an unloaded tool and always keep tool pointed in a safe direction.
- Disconnect air when clearing jams, servicing or when tool is not in use.
- Use only clean, dry, regulated air not exceed 110 psi.
- Never use oxygen or other bottled gasses-explosion may occur.
- Do not tie down, alter or remove the Safety Trigger.

**CAUTION**

1. Do not tie down the Safety Trigger
2. To prevent accidental discharge never attach air hose to loaded Nailer.

**Caution:**  
To  
Prevent  
Accidental  
Discharge  
Never  
Attach  
Air Hose  
To  
Loaded  
Nailer

**CAUTION:**  
Lubricate  
Nailer with  
2-4 drops of  
Industrial Light  
Oil for every  
8 hours of use.

↑  
**R  
E  
L  
O  
A  
D**

Refill the nail channel with a clip of Powercleats when empty.

Pull the Nail-Pusher assembly to the back of the channel when cleats are reloaded.



Nailer is activated by striking the plunger. Do not work on scaffolding, ladders, elevated or uneven surfaces where the nailer could fall and self-activate. Do not leave air attached to the Nailer when moving from one install location to another.

## POWERNAIL FLEX PARTS LIST

For this parts list and other Powernailer schematics, please visit the  
Powernail Parts Store at [www.powernail.com](http://www.powernail.com)

Item #	PART NO.	DESCRIPTION	Qty Req'd	Tuneup Kit	Seal Kit	Sold Separate or Assembly #
1	09-50P-3001	Body	1			F
2	09-50P-3002	Cap	1			S
4	09-445-29703	Handle - Long	1			S, A-2
6	09-445-29704	Handle Half Cover	1			S, A-2
8	09-50P-3006	Foot	1			S, A-4
9	09-50P-3008	Channel	1			S, A-4
10	09-50P-3010	Piston Rod	1			S, A-6
11	09-200-3011	Piston	1			S, A-6
12	09-200-3013	Return Cylinder	1			S, A-6
13	09-200-3014	Plunger	1			S, A-6
14	09-200-3015	Cylinder Sleeve	1			S
15	09-50P-3042	Gate (Replaces 09-50P-3016)	1	TU		S, A-4
16	09-50P-3017	Gate Plate	1	TU		S, A-4
17	09-50P-3018	Driving Blade	1	TU		S, A-6
18	09-200-3022	Rubber Cap	1	TU		S
19	09-200-3026	Piston U-cup Lip Seal	1	TU	SEAL	S, A-1, A-6
20	09-200-3027	Return Cylinder U-cup Lip Seal	1	TU	SEAL	S, A-1, A-6
21	09-200-3028	Piston Rod U-cup Lip Seal	1	TU	SEAL	S, A-1, A-6
22	09-200-3034	Nail Pusher Spring	1			S, A-4, A-9
23	09-200-3035	Spool	2			S, A-4, A-9
24	09-445-29832	#10-32 X 3/4 SHCS w/patch (Plunger)	3			S, A-6
25	09-200-3057	#10-32 X 1/2 FHCS Slotted (Pad)	4			S
26	09-445-29707	Safety Yoke	1			S
27	09-2003019	Body Plate (.035 Thick)	1			S
28	09-445-29720	Trigger	1			S, A-2
29	09-445-29721	Support Ring	1			S
30	09-445-29723	Rubber Seat	1	TU	SEAL	S, A-1, A-6
31	09-445-29724	Rubber Bumper	1	TU		S
32	09-445-29725	Plunger Seal Set	1	TU	SEAL	S, A-1, A-6
33	09-445-29729	Plunger Wiper Metal Cap O-Ring	1	TU	SEAL	S, A-1
34	09-445-29731	Return Cylinder O-ring Gasket	1	TU	SEAL	S, A-1, A-6
36	09-445-29732	Trigger Cable - Long	1			S, A-2
38	09-445-29733	Safety Yoke Springs	2			S
39	09-445-29735	Nail Pusher	1			S, A-4, A-9
40	09-445-29735.2	Nail Pusher Knob	1			S, A-4, A-9
41	09-445-29739	1/4 X 3/4 Dowel Pin (Trigger)	1			S, A-2
42	09-445-29740	1/4 X 1/2 Dowel Pin (Driving Blade)	1	TU		S, A-6

KEY: S=Sold Separately, A= Sold as part of assembly, SEAL=Seal Kit, TU=Tune-up Kit, F=Factory Only

Item #	PART NO.	DESCRIPTION	Qty Req'd	Tuneup Kit	Separate, or Assembly
43	09-445-29741	1/8 X 5/8 Roll Pin (Gate)	2		S, A-4
45	09-445-29743	1/4-20 X 1 SHCS (Cap)	4		S
46	09-445-29744	1/4-20 X 3/4 SHCS w/patch (Handle Base)	4		S
47	09-445-29745	#10-32 X 1-1/4 SHCS (Knob)	1		S, A-4,A-9
48	09-445-29747	1/4-20 X 1-1/4 SHCS W/patch (Foot)	4		S
49	09-445-29748	5/8-18 Jam Nut (Driving Blade)	1	TU	S, A-6
50	09-445-29750	#8-32 X 1-1/2 FHCS (Spacer)	2		S, A-4
51	09-445-29751	#8-32 Locknut (Spacer)	2		S, A-4
52	09-445-29754	#10-32 X 1/2 SHCS (Foot)	4		S, A-4
53	09-445-29756	1/4 X 1 Spacer (Channel)	2		S, A-4
54	09-445-29758	1/4 Split Ring Lock Washer (Foot)	4		S
55	09-445-29759	3/8 NPT 45 Degree Street Elbow	1		S
56	09-445-29760	#8-32 X 1/4 BHCS (Cable)	1		S
57	09-445-29822	#10-32 X 3/4 SHCS w/patch (Gate)	3	TU	S, A-4
60	09-50P-3040	Channel Plate	1		S, A-4
61	09-50P-3041	#6-32 X 3/8 BHCS (Channel Plate)	2		S, A-4
63	09-445-297441	1/4-20 x 3/4 SCHS (Handle Half)	2		S, A-2
70	09-50P-3070	FLEX Foot	1		S
71	09-50P-3071	FLEX Foot Bracket	1		S
72	09-50P-3072	FLEX Foot Cam	1		S
73	09-50P-3073	FLEX Foot Cam Plate	1		S
74	09-50P-3074	FLEX Foot Pad	1		S
75	09-50P-3075	FLEX Adj SHCS 1/4-28 x 1.25"	2		S
76	09-50P-3076	Washer .281 IDx.62 ODx.051" T	2		S
77	09-50P-3077	BHCS #10-32 x .50" w/patch	2		S
78	09-50P-3078	1/4 SH DIA x .50" SH. Bolt	1		S
79	09-50P-3079	Belleville Disc Spring	1		S
90	09-50P-3090	FLEX Adapter Foot	1		S
94	09-445-29801	FLEX Foot 3/16" Allen Wrench	1		S

KEY: S=Sold Separately, A= Sold as part of assembly, SEAL=Seal Kit, TU=Tune-up Kit, F=Factory Only

## Powernail FLEX Assemblies, Kits and Accessories

ITEM	PART NO.	DESCRIPTION	QTY
A-1	09-200-3058A	Seal Kit (1 Each Of All Seals) (also in Tune-up Kit)	1
A-2	09-445-29759A	Long Handle Assembly	1
A-4	09-50P-3065A	Nail Channel Assembly (Standard)	1
A-6	09-50P-3064A	Driving Blade Assembly w/Rubber Seat	1
A-7	09-AW-445	Allen Wrench Set (3/16 & 5/32)	1
A-8	09-445-29757A	6 oz. Industrial Light Air Tool Oil	1
A-9	09-200-3063A	Nail Pusher Assembly	1
A-11	09-445-29766	3/8" M & F Coupling Set	1
A-12	09-445-29768	Box Wrench (2)	2
	09-50PTUKIT	Tune-up Kit for all 50P, 50P FLEX, & 50P Power Rollers	1

# SEAL PLACEMENT

SEAL P/N & LOCATION

#33

PLUNGER WIPER SEAL  
#09-445-29729

#21

PISTON ROD U-CUP SEAL  
#09-200-3028  
INSTALL AS SHOWN

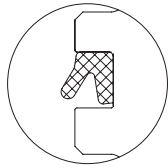

#20

RETURN CYLINDER U-CUP SEAL  
#09-200-3027  
INSTALL AS SHOWN

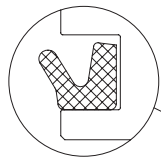
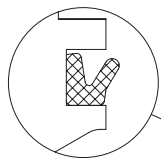

#19

PISTON U-CUP SEAL  
#09-200-3026  
INSTALL AS SHOWN

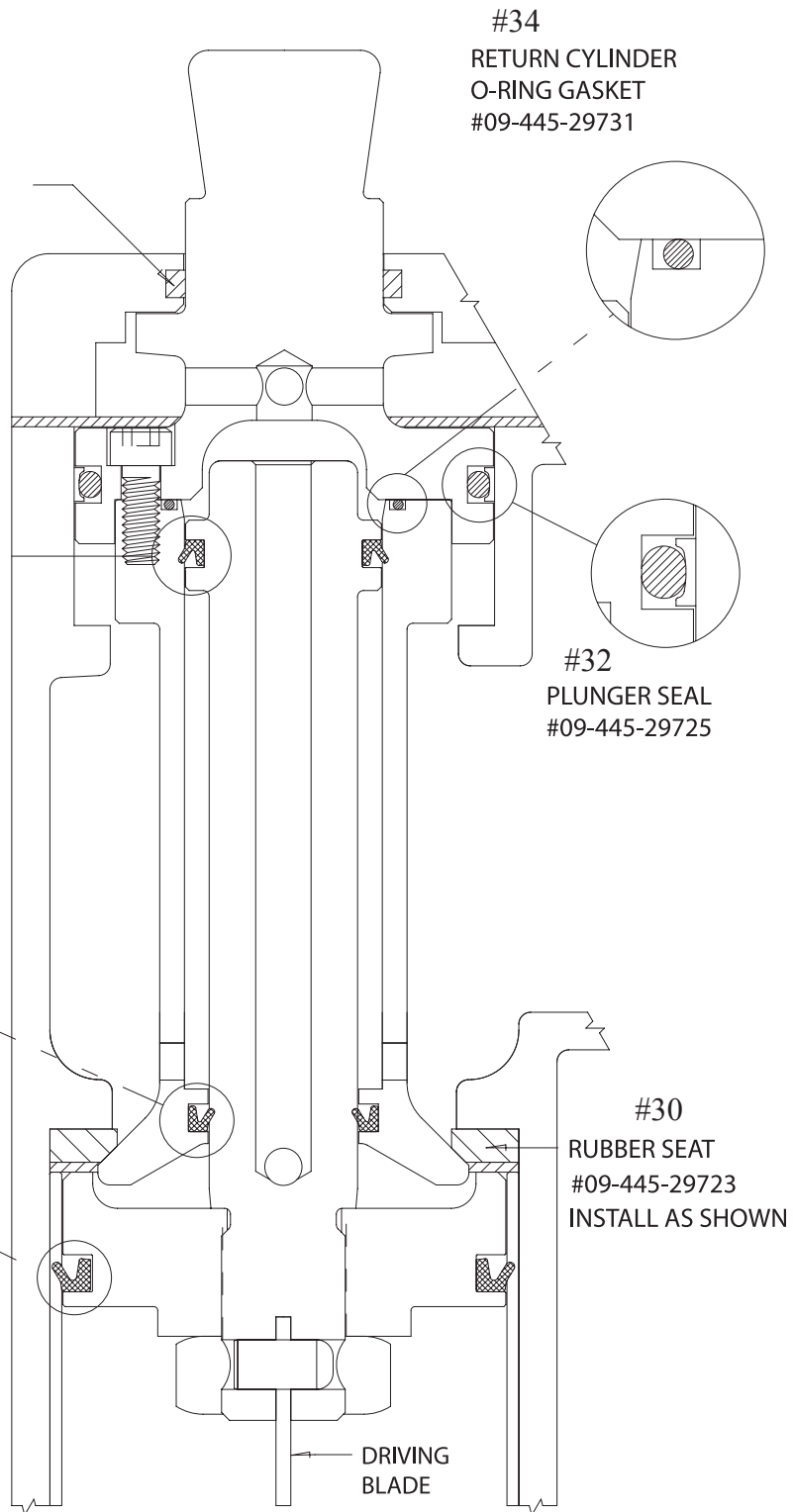

#34

RETURN CYLINDER  
O-RING GASKET  
#09-445-29731

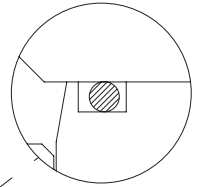

#32

PLUNGER SEAL  
#09-445-29725

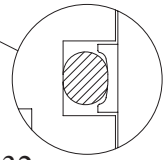

#30

RUBBER SEAT  
#09-445-29723  
INSTALL AS SHOWN

DRIVING  
BLADE



# POWERNAIL FLEX SCHEMATIC

**For this and other Powernailer schematics, please visit the  
Powernail Parts Store at <http://www.powernail.com>**

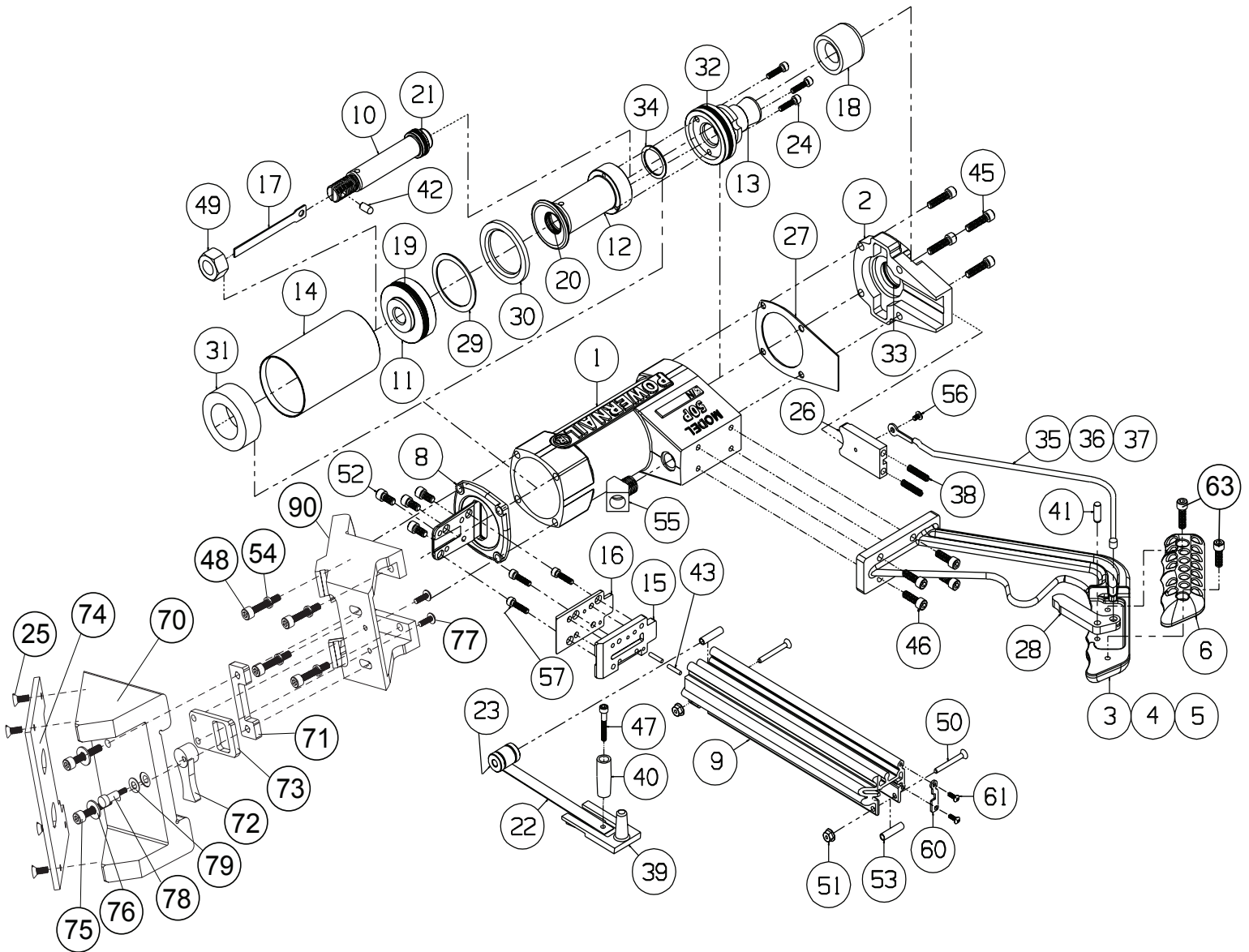

**Kits Available - For use on all Model 50P, 50P FLEX, & 50P FLEX Power Rollers**

Seal Kit (1 Each Of All Seals)	Tune-up Kit	Overhaul Kit
Part #: 09-2003058A Schematic #'s: 19,20,21,30,32,33	Part #: 09-50PTUKIT Schematic #'s: 15,16,17,18, 19,20,21,30,31,32,33,34, 42,43(2),49,57(3)	Part #: 09-50POVHKIT Schematic #'s: 10,11,12,13,15,16,17,18, 19,20,21,22,23,24,30,31,32,33,34,39,40, 42,47,49,57(3)

***For Step-by-Step Videos and Instructions,  
Visit our Web Site at: [www.Powernail.com](http://www.Powernail.com)***

# POWERCLEATS LENGTH DETERMINATION CHART

This chart will assist you in determining the proper length of Powercleats to use for various thicknesses of flooring. Approximate vertical penetration of the Powercleat under the hardwood floor is shown for each application. This is only a guide. Results should be tested in the field before proceeding.

## Nail Penetration for 3/4" and 5/8" Underlayment

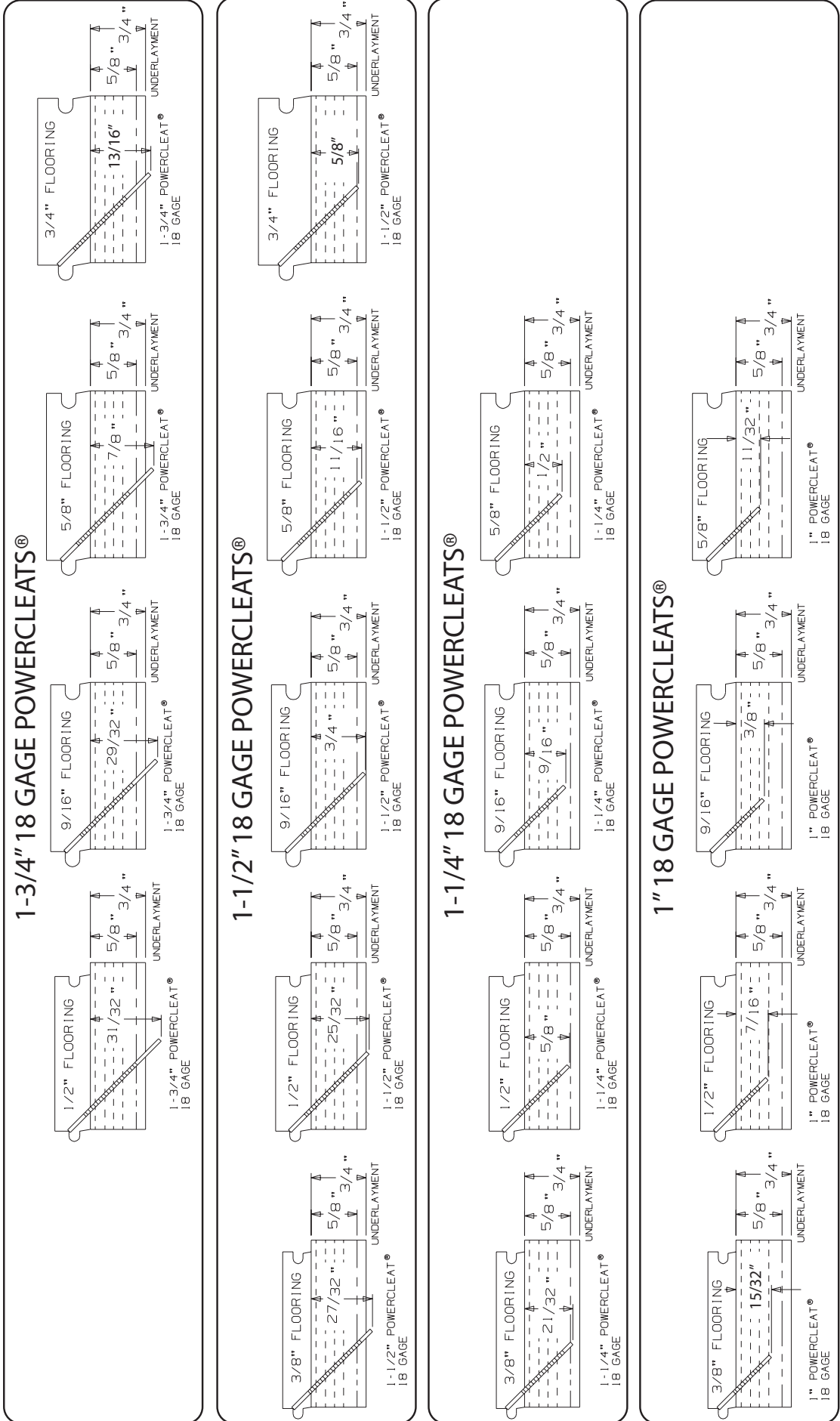

## POWERNAILER TROUBLE SHOOTING CHART

	PROBLEM	POSSIBLE CAUSE	SOLUTION
1	Driving blade does not retract	1. Zero or Low air pressure	Check air supply for 80 psi minimum to 110 psi maximum
		2. Lack of lubrication	Manually lubricate through male air inlet fitting
		3. Excessive dirt inside nailer	Disassemble and clean
		4. Bent or burred driving blade	Replace driving blade (#17)
		5. Seals worn out	Replace all seals (Seal Kit)
		6. U-Cup Lip Seals installed upside down	Replace all seals (Seal Kit)
2	Driving blade retracts slowly	1. Low air pressure	Turn up air pressure to 80-110 psi max
		2. Bent or burred driving blade	Replace driving blade (#17)
		3. Air supply restricted by small orifice	Use 1/4" minimum diameter air fittings
		4. U-Cup Lip Seals installed upside down	Replace all seals (Seal Kit)
		5. Excessive dirt inside nailer	Disassemble, clean and lubricate
3	Nail is not countersunk	1. Low air pressure	Turn up air pressure to 80-110 psi max
		2. Broken Driving Blade	Replace Driving Blade (#17)
		3. Nail hit hard surface	Move from obstruction
		4. Piston U-Cup Lip Seal installed upside down	Replace all seals (Seal Kit)
		5. Driving blade jam nut came loose	Retighten or replace jam nut (#49)
		6. Worn out gate	Replace gate. (#15)
4	Nailer leaks air	1. Air supply fittings loose	Tighten all air line fitting connections
		2. Excess air pressure blew out seals	Check air supply for 110 psi maximum—replace all seals
		3. Plunger screws loose	Tighten 3 plunger screws (#24)
		4. Cracked or damaged body	Replace body (#1)
		5. Seals worn out	Replace all seals (Seal Kit)
		6. Seals need to be seated	Dry fire Nailer
5	Bottom of nailer cracked off	1. Operated without rubber bumper installed	Replace damaged parts
		2. Excessive air pressure used	Replace damaged parts
6	Nails jam in nailer	1. Not using 18 gage Powercleats nails	Use 18 gage Powercleats nails only
		2. Continued use after a short hit	Clear nail immediately after short hit
		3. Nail pusher damaged or spring broken	Replace nail pusher assembly (#A-9)
		4. Nail channel lose	Tighten nail channel retaining screws (#52,#48)
		5. Bent nail stuck in nail guide	Disassemble and clear out bent nail
		6. Hit another set nail or hard object	Move from obstruction
		7. Nail gate worn out	Replace nail gate (#15)
7	Plunger locked up—won't move or fire	1. Safety trigger not being depressed	Replace damaged plunger, safety yoke and plunger seal (#13,#26,#32)
		2. Lack of lubrication	Manually lubricate through male air inlet fitting

## Visit [www.Powernail.com](http://www.Powernail.com)

- Dealer Locator
- Rental Locator
- Parts Store
- Product Information
- Repair Tech Videos
- Cool Tools Cleat Calculator
- Cleat Depth Chart
- Training Schools

### **Featured Accessory Products**

#### **Powerjack® Model 500**

Truly a Tinker's TOOL, the POWERJACK Model 500 is designed to push or pull flooring strips into place and hold them tightly. The PowerJack Model 500 self adjusts from 5/16" to 3/4" thickness flooring. It can be used to either push or pull wood flooring strips into place and ratchets tightly for hands free operation. The base of the PowerJack 500 has mounting holes for mid-floor use. Simply screw nail the PowerJack 500 to your sub floor -in front of your flooring strips -and ratchet the flooring strips tight. Also great for under cabinet and kick plate installation.

**Part number: 06-99650**

#### **The PowerPalm™**

"The PowerPalm is the industries best solution to blind nailing close to the wall. Saves both, time and money!"

Pressure activated...simply press down, and let the tool do the work. The Power Palm will allow blind nailing closer to the wall and reduce the amount of face nailing. "Blind nail, top nail...tight spots and corners, the PowerPalm gets them all!" Featuring 360 degree swivel tip for fitting awkward or tight spaces. Magnetic cleat holder keeps nail in position. Uses both 16 gage and 18 gage Powercleats—Use the same fastener throughout your install! **Part number: 02-PALM001**



**Powerjack  
Model 500**



*Closest you  
can get to  
the wall!*

**Pneumatic PowerPalm™**

#### **Powernailer® TOOL BAG™**

The TOOL BAG holds all Powernailer® configurations including the FLEX and POWER ROLLER models. The Powernail TOOL BAG is built tough with a double wall of padded industrial nylon to protect your tools. Corners are reinforced with leather for durability. Zippered storage pouch on the inside (12" x 6"). The Tool Bag has two durable handles which can be used for carrying over your shoulder.

Dimensions: 20" base, 7" deep and 20" Tall.

**Part number: 06-99201**



**TOOL BAG**